

# Simpole F1 Installation Guide

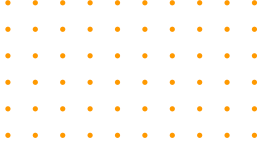

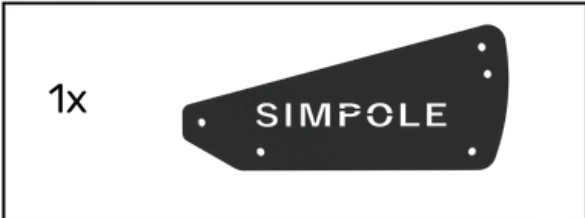

# STEP-1

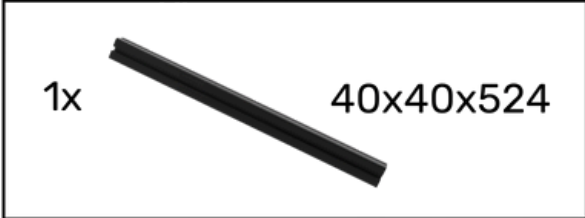
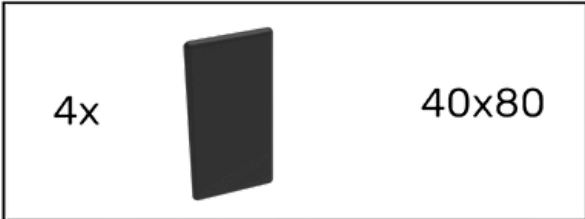
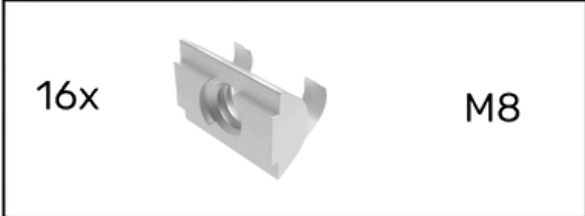
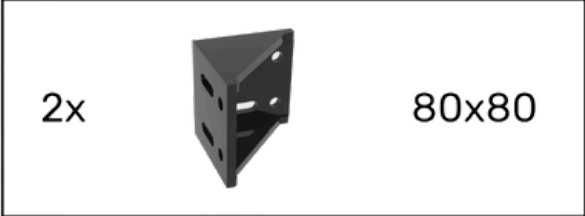
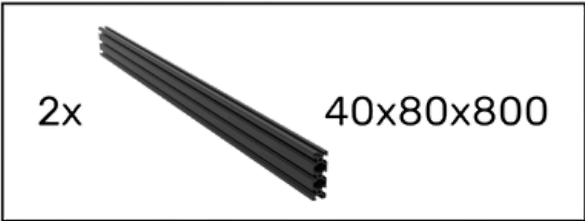

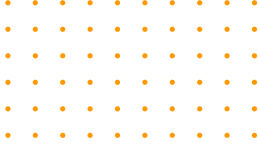

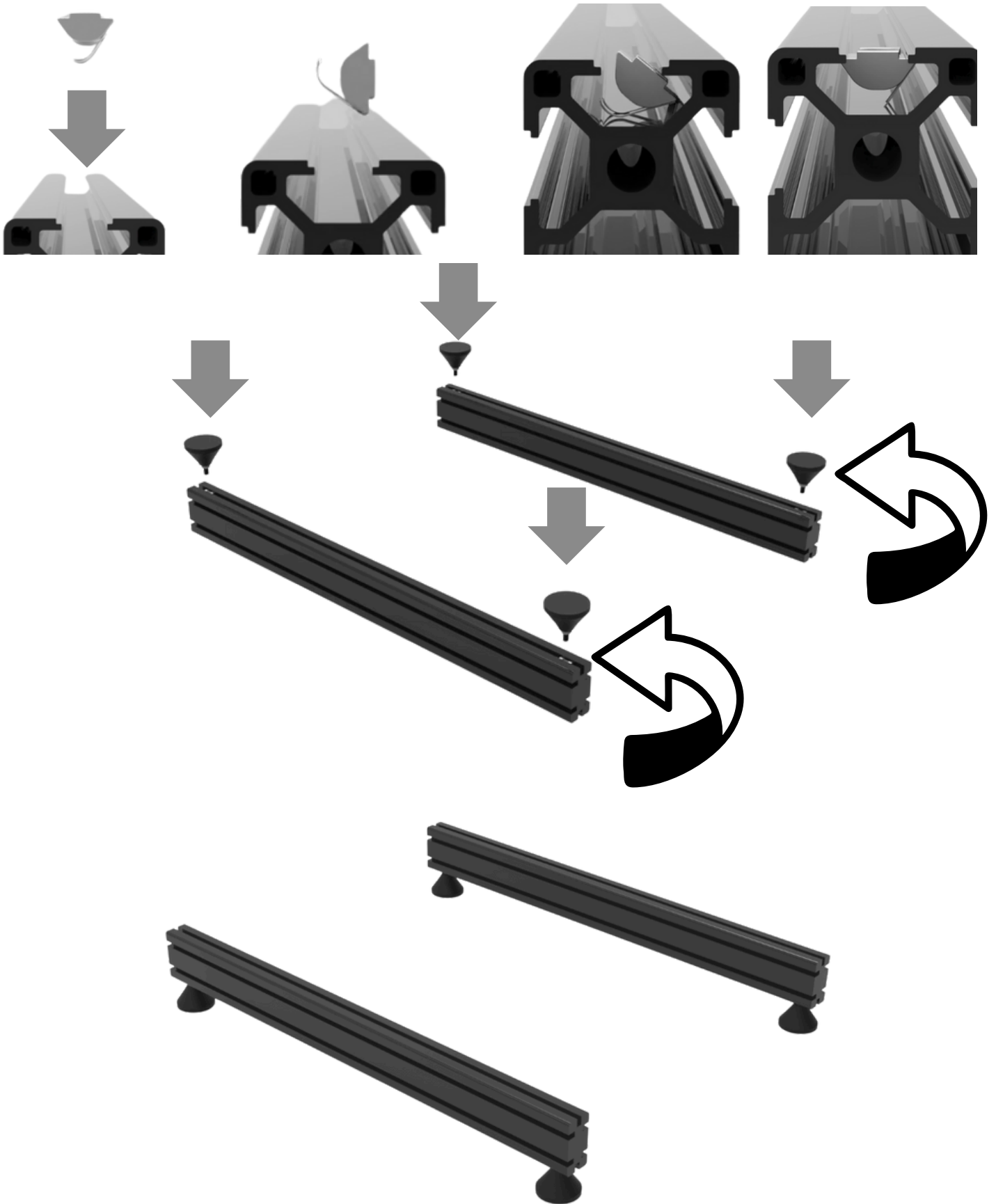

## Tee-Nut Inserting Process

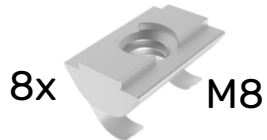
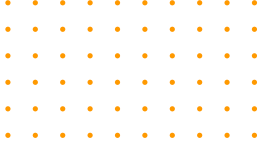

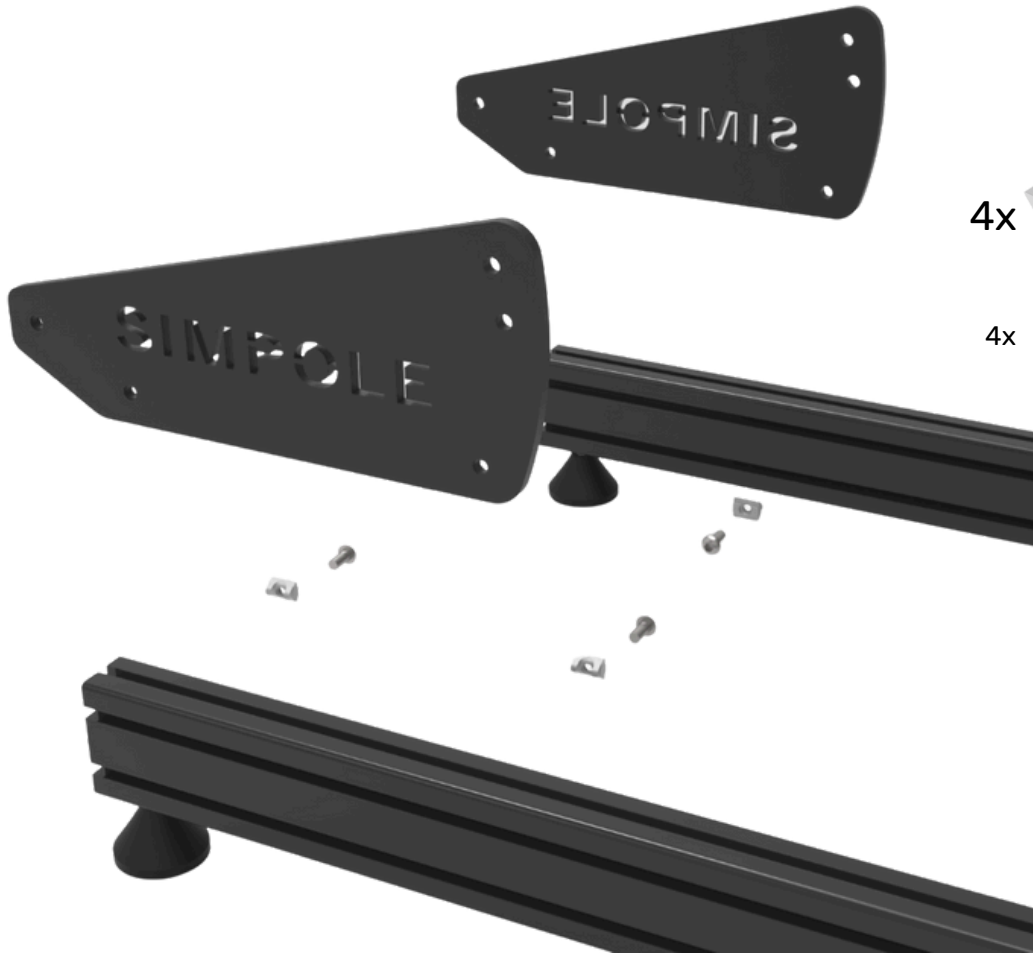
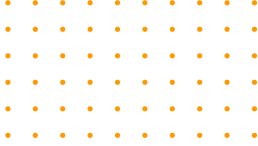

80x80

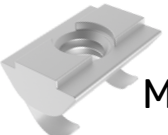

- 4x  M8
- 4x  M8x20

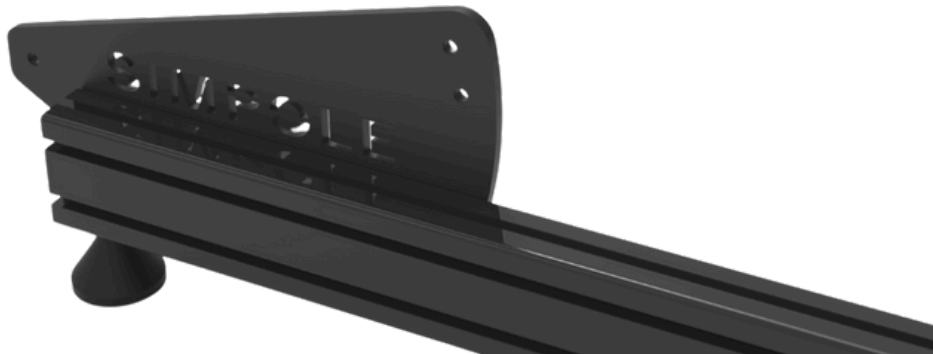

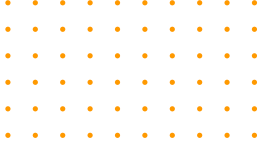

## STEP-2

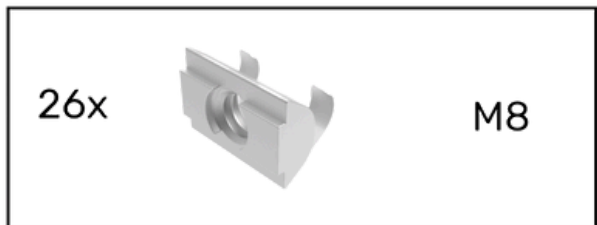
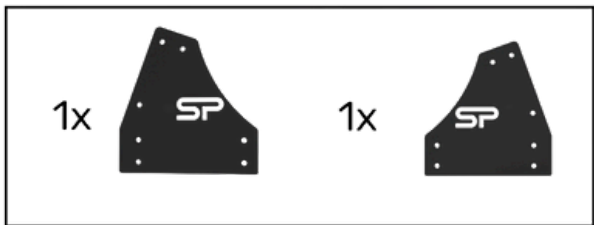
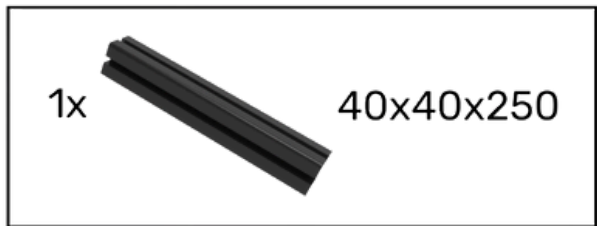
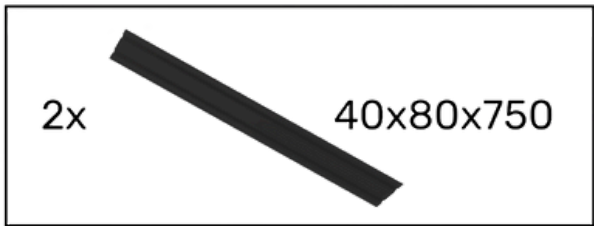

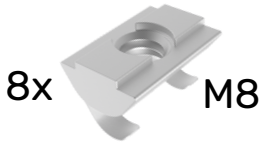
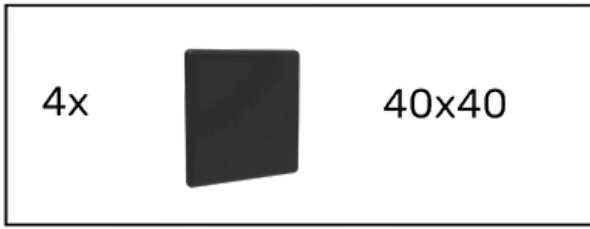
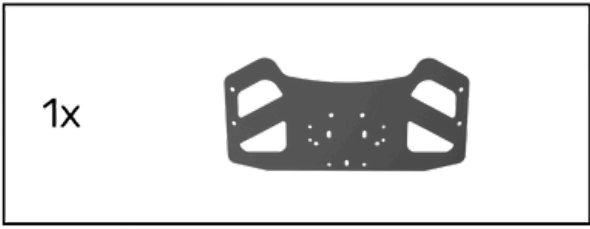
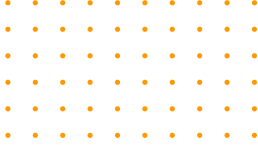

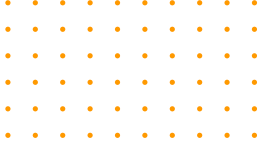



40x80x750

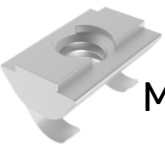



- 6x  M8
- 6x  M8x20



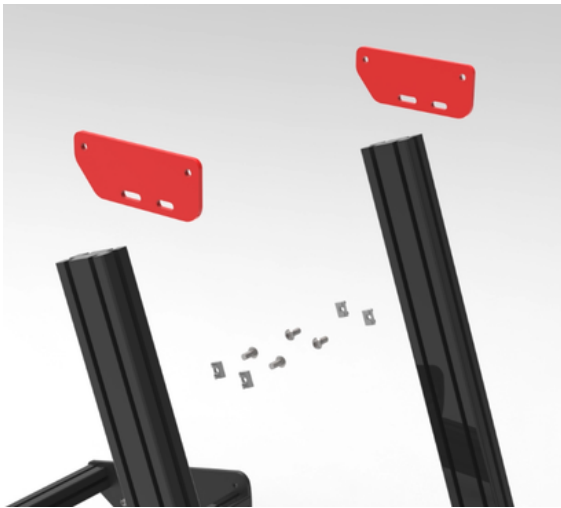
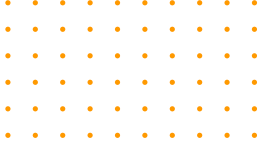



- 4x  M8
- 4x  M8x20



- 2x  40x80



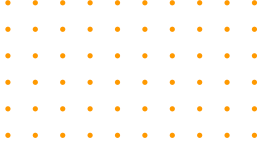

4x

40x40

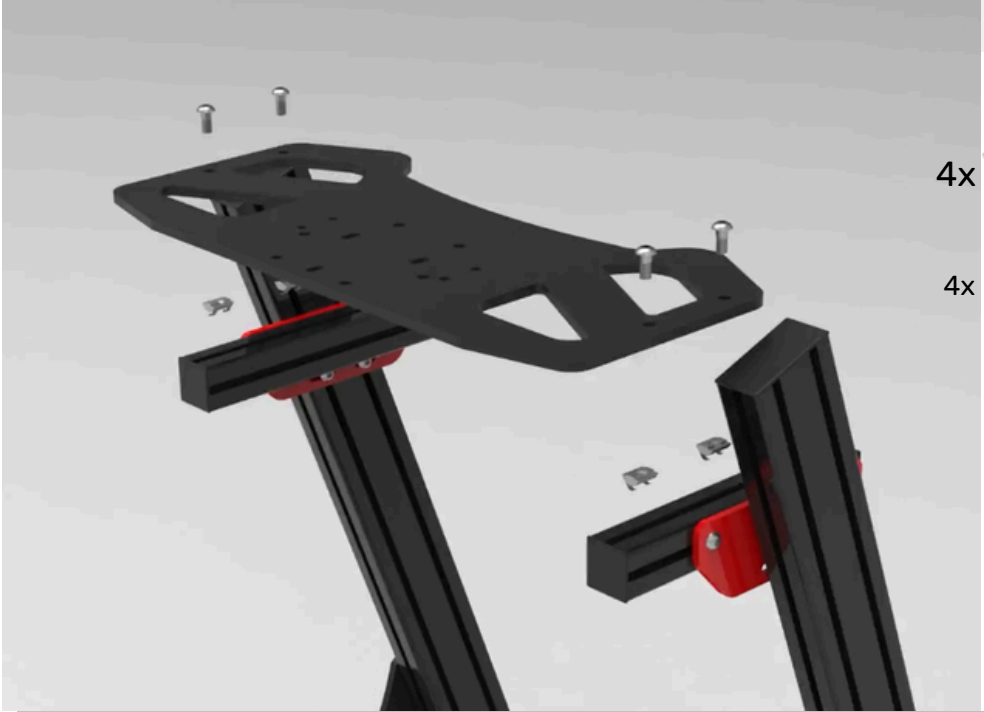

4x

M8

4x

M8x20

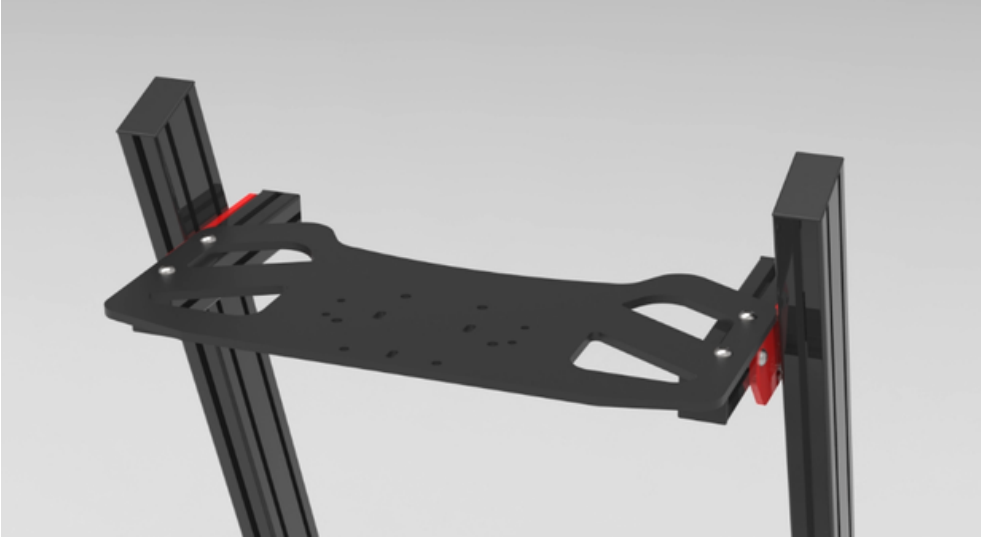

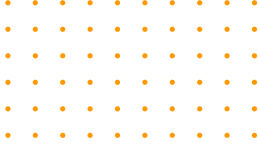

# STEP-3

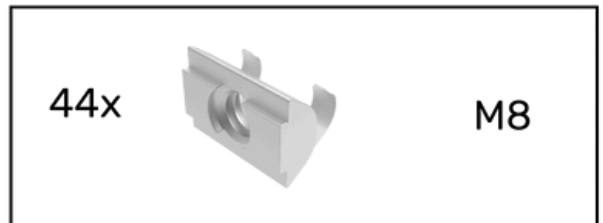
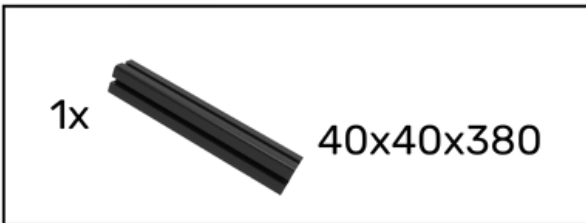
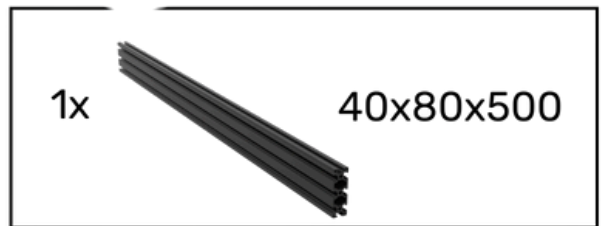
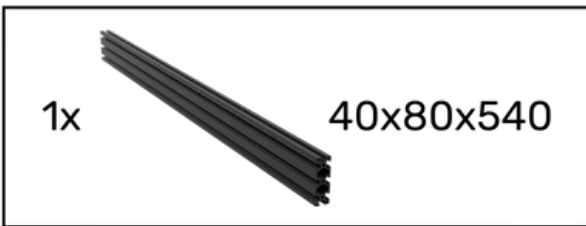
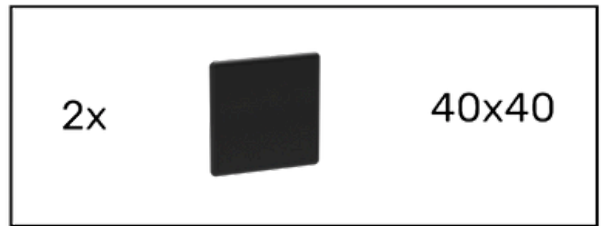
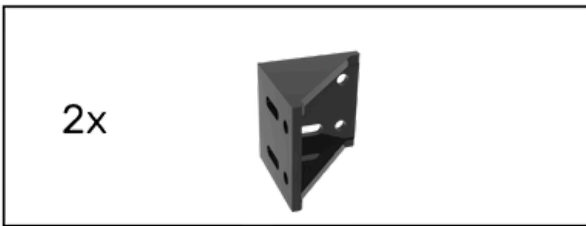
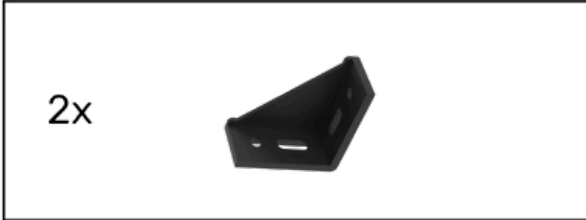
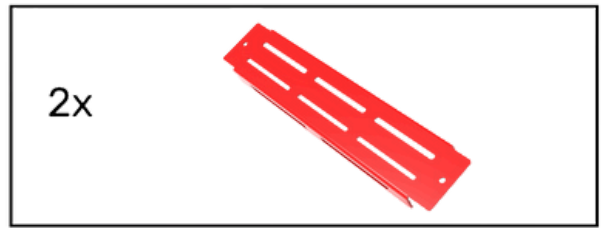
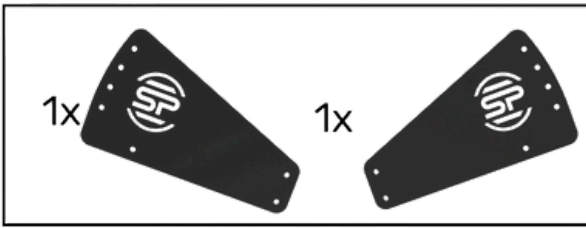

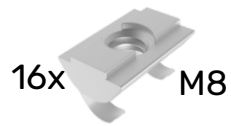
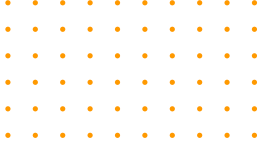

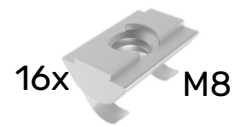
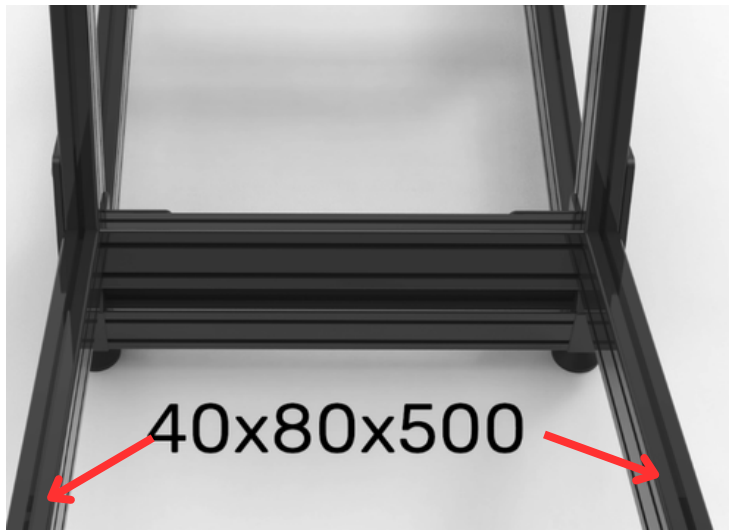
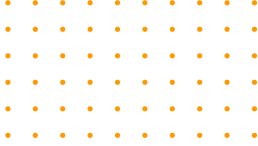

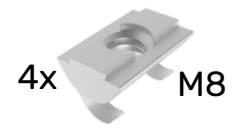
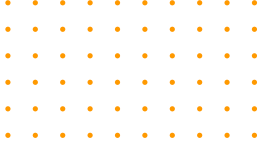

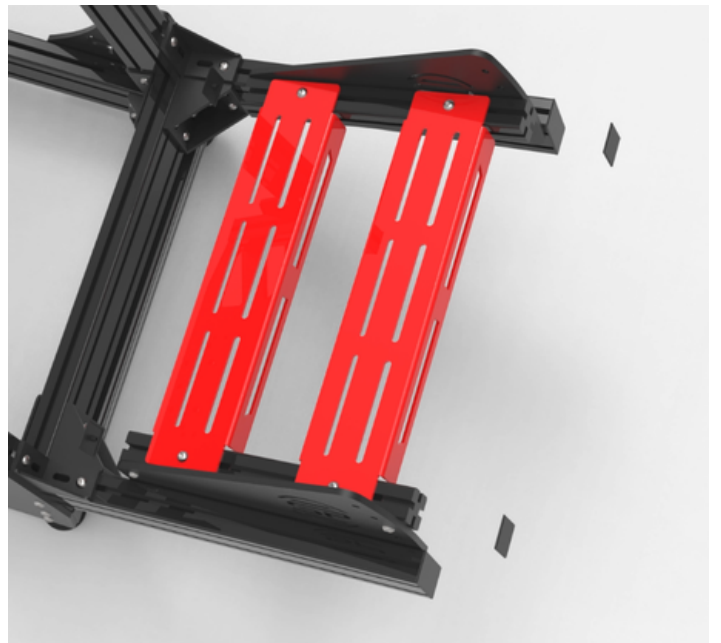
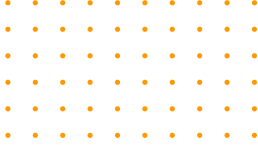

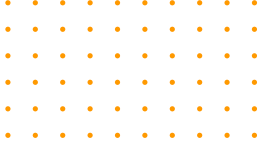

# STEP-4

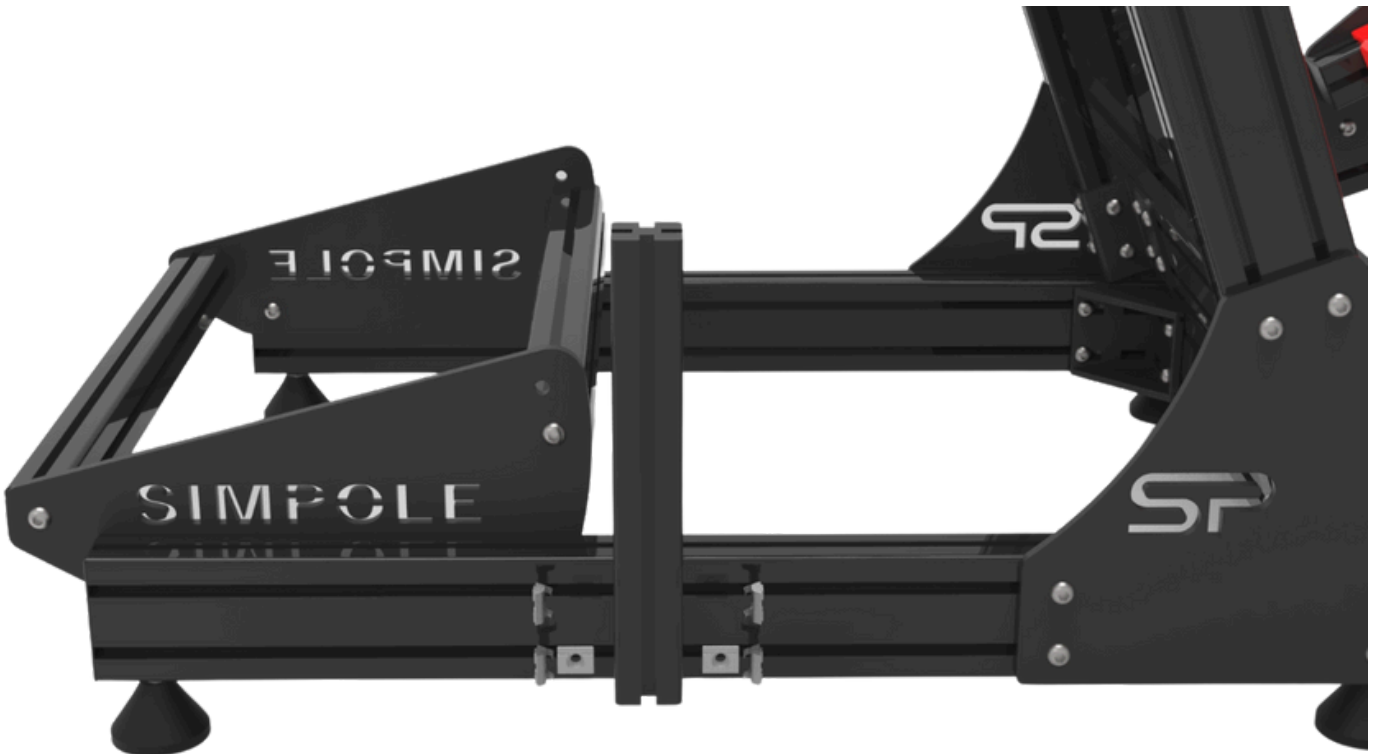
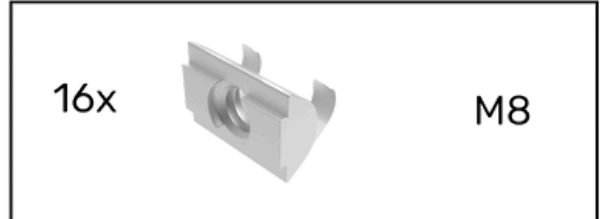
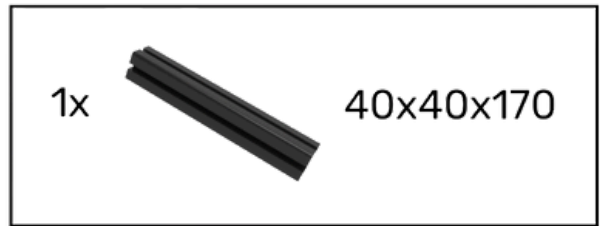
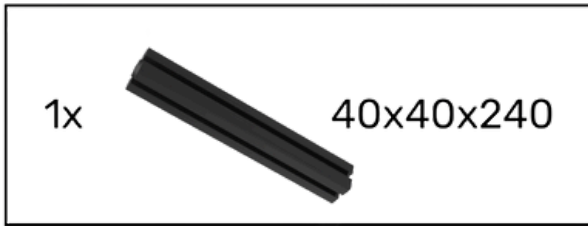



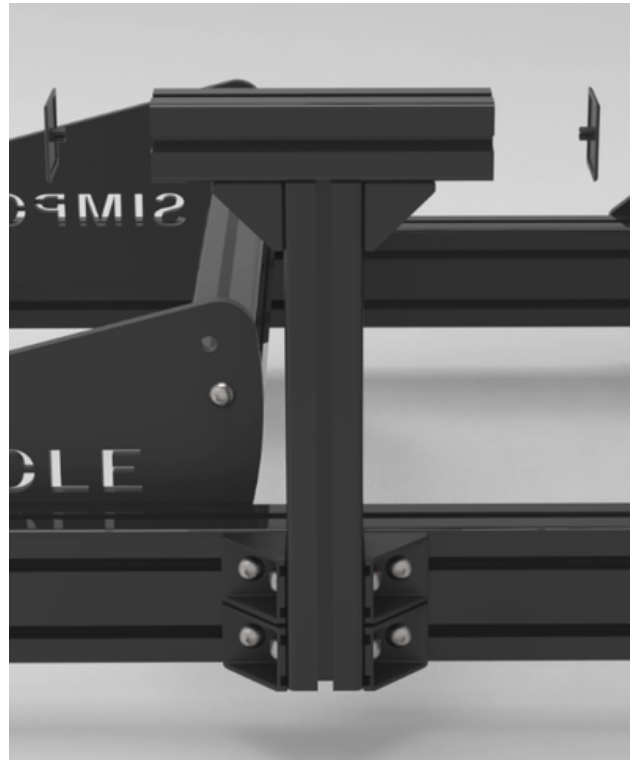
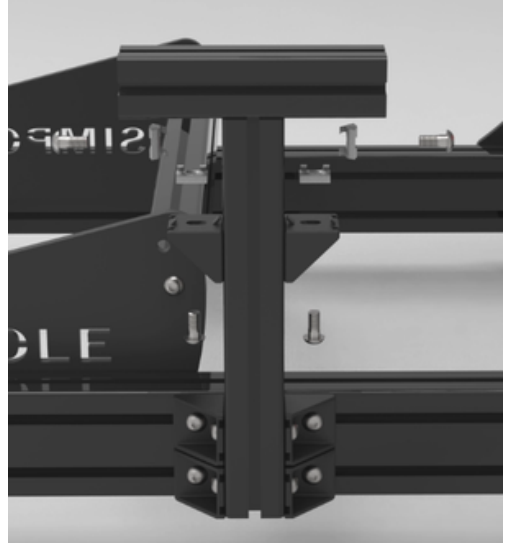
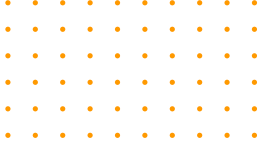

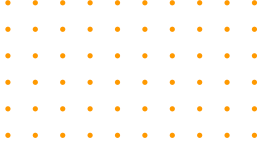

# STEP-5

