

Simpole Podium 60 Installation Guide

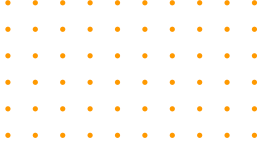

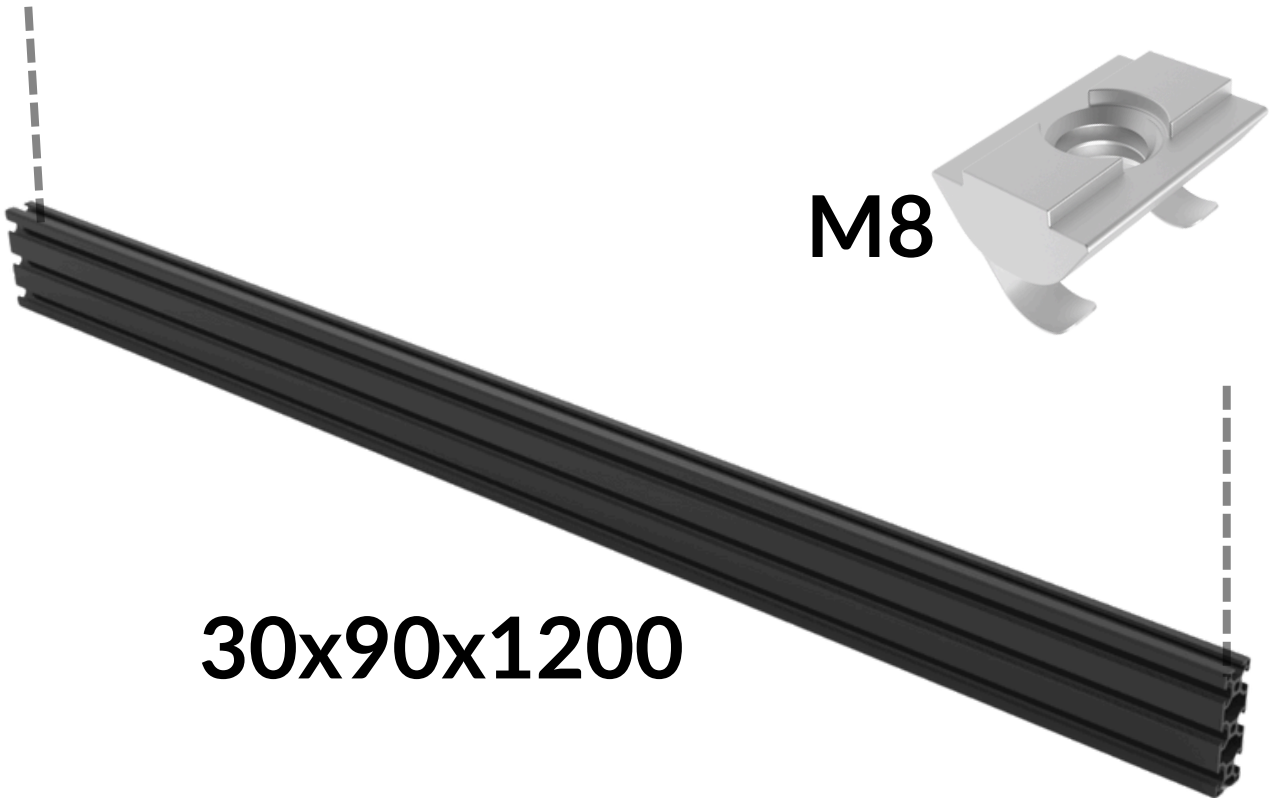

STEP-1

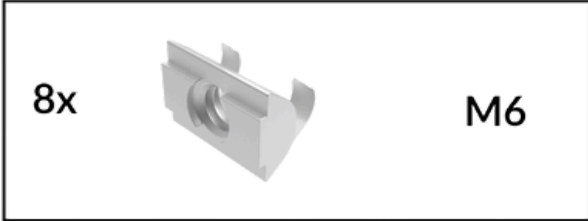
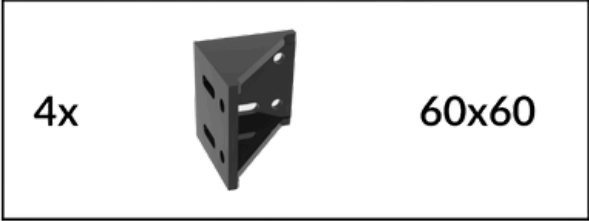
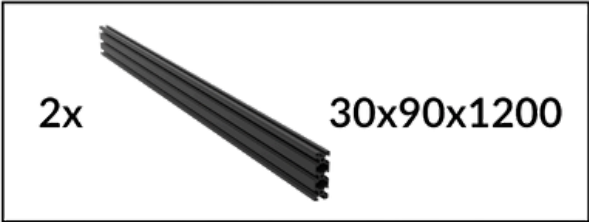

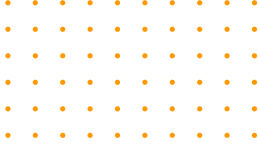

Tee-Nut Inserting Process

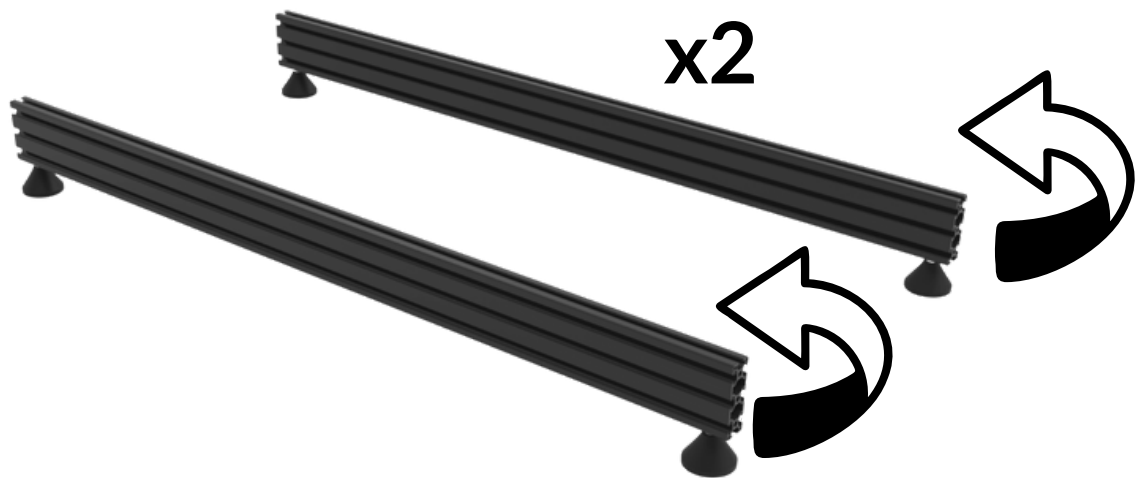
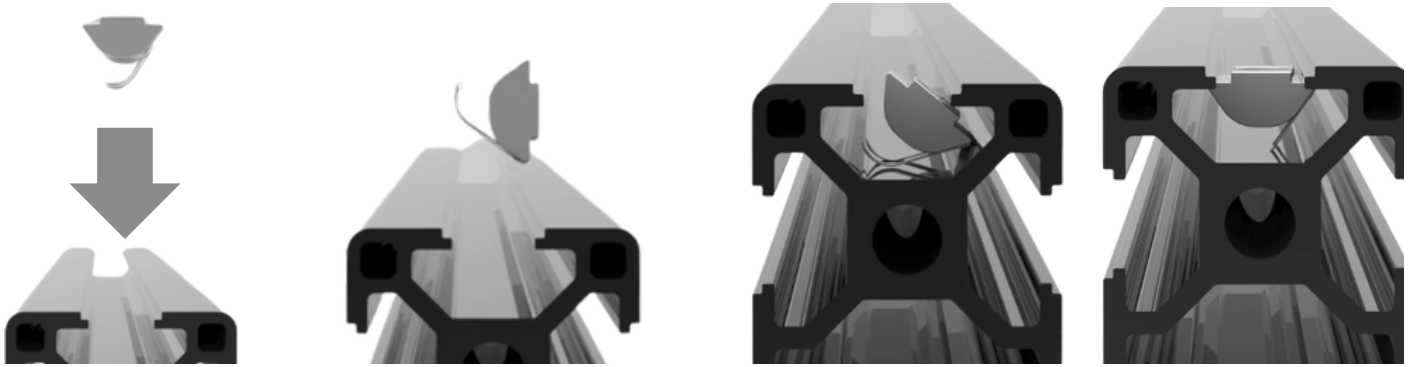

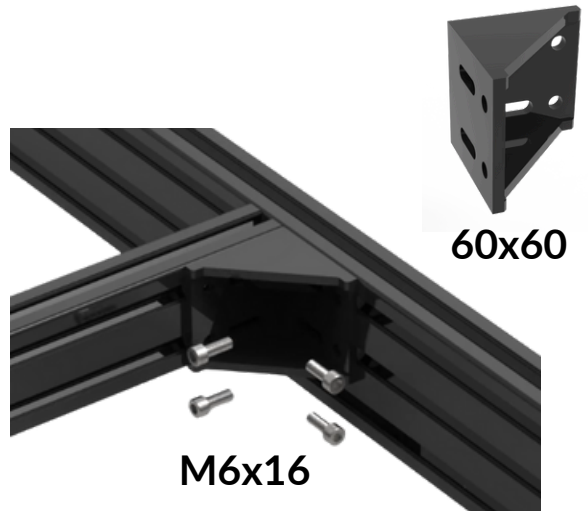
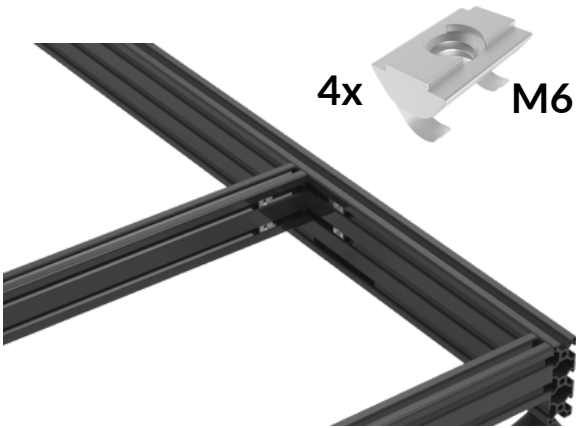
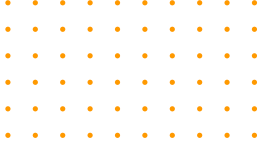

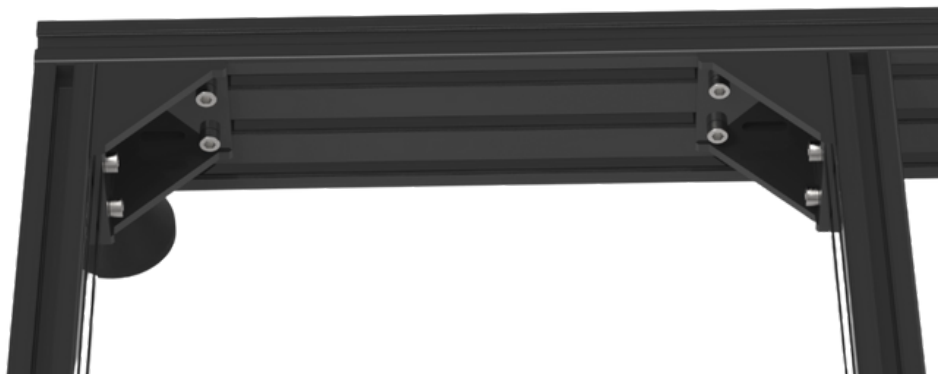
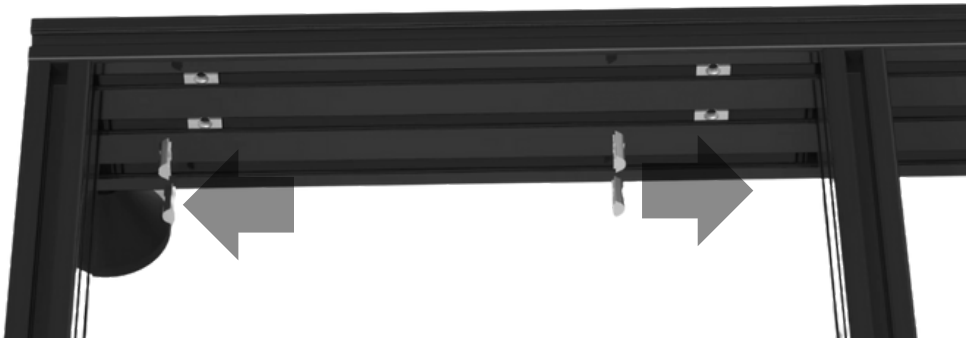
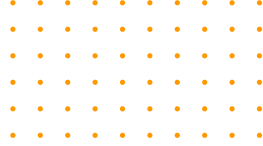

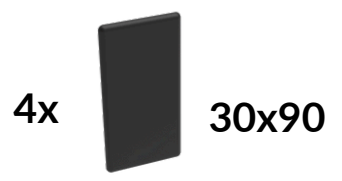
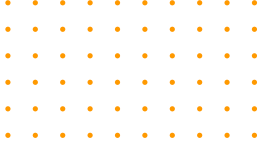

STEP-2

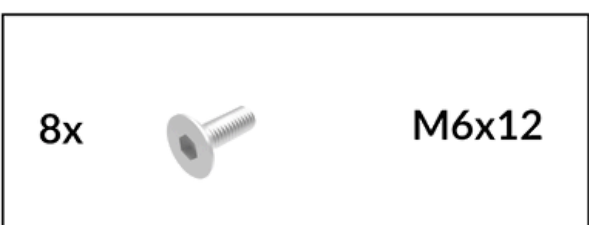
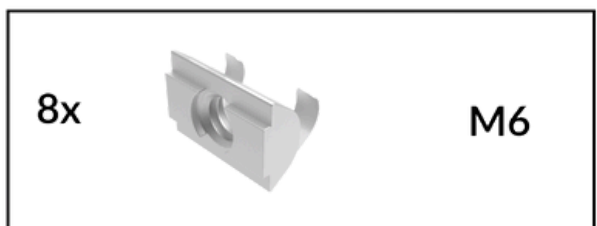
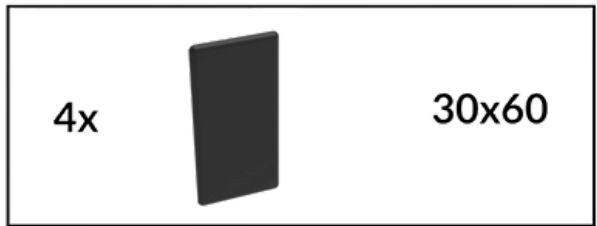

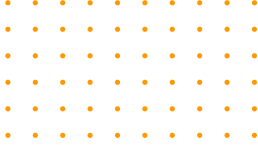

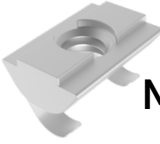
8x  M6



4x  30x30

8x  M6x12

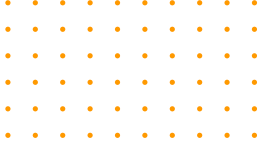

STEP-3

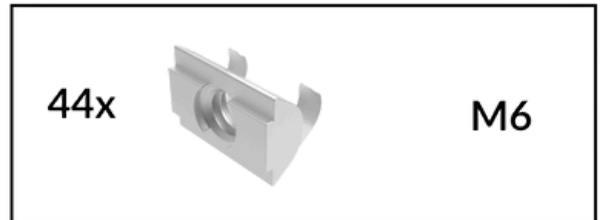
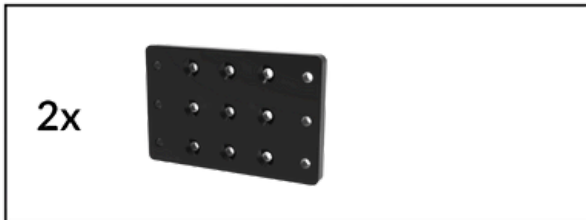
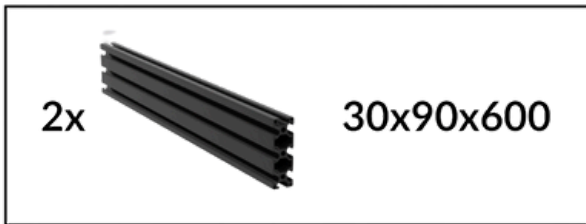

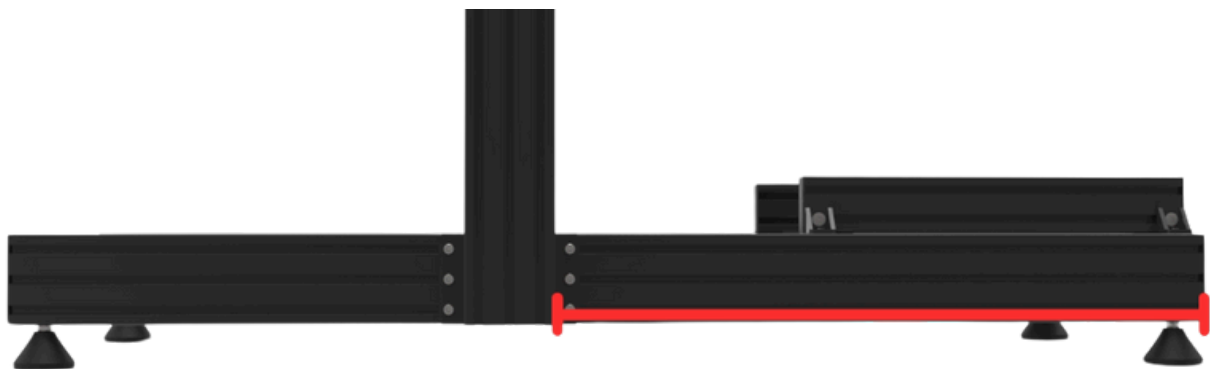
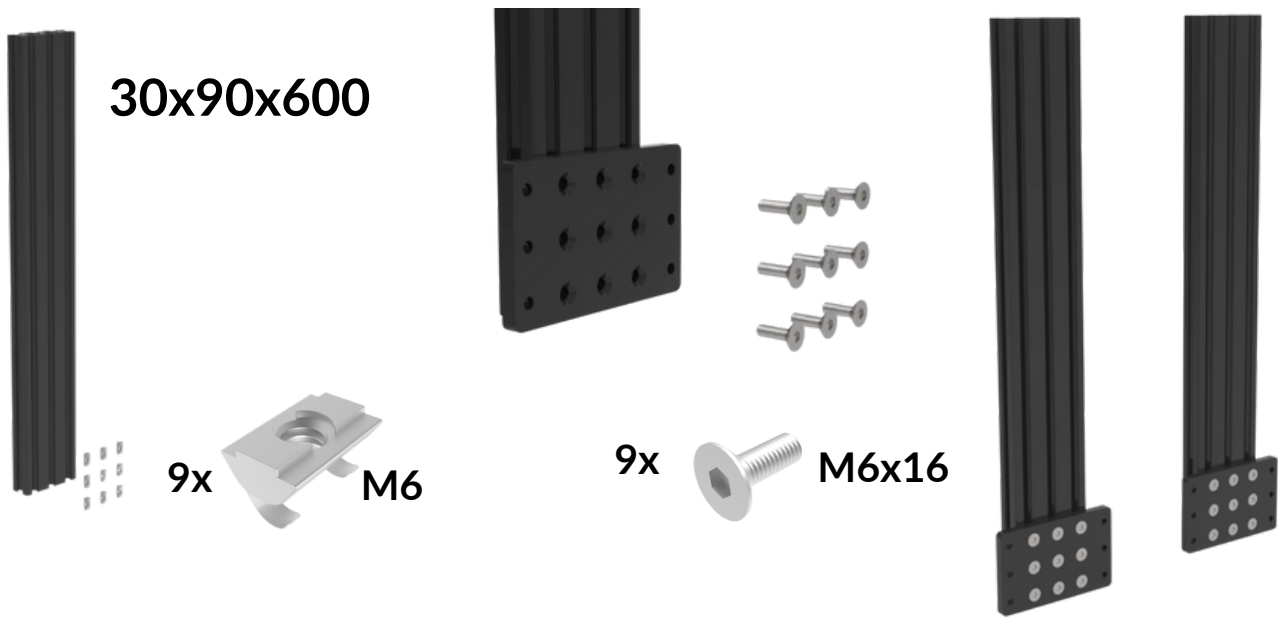
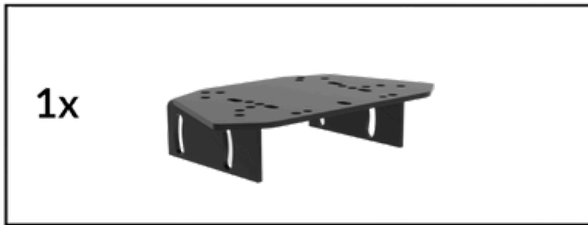
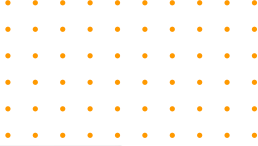

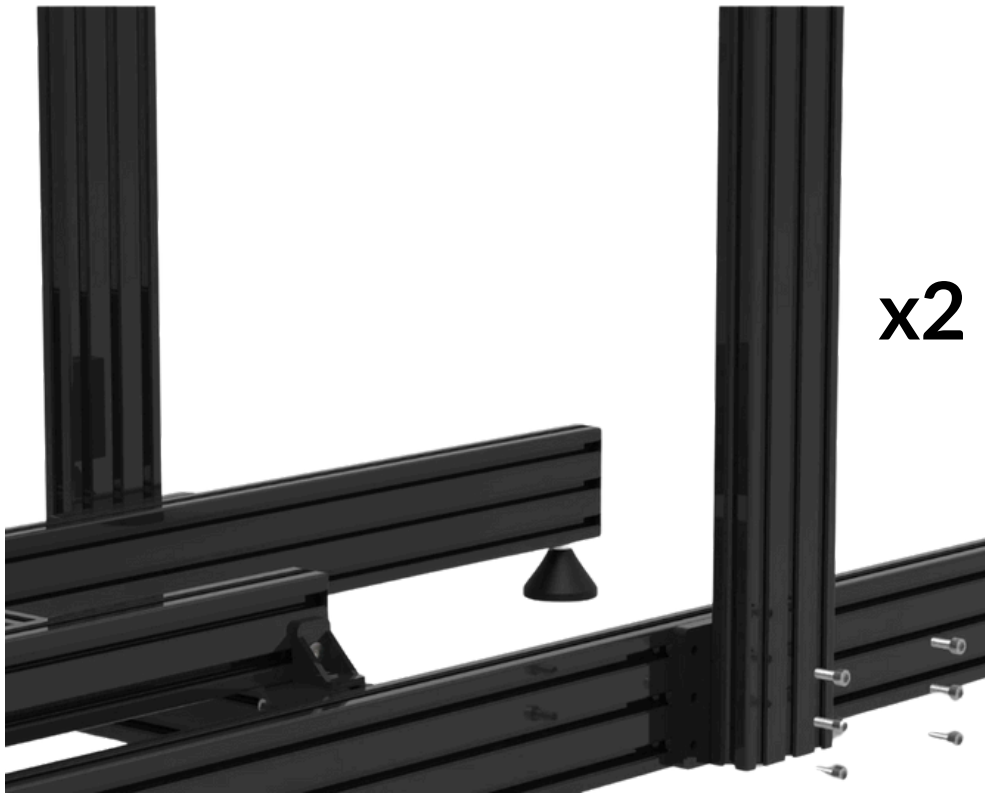
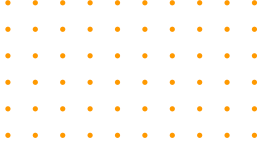

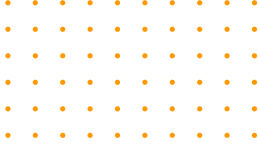

30x90x560



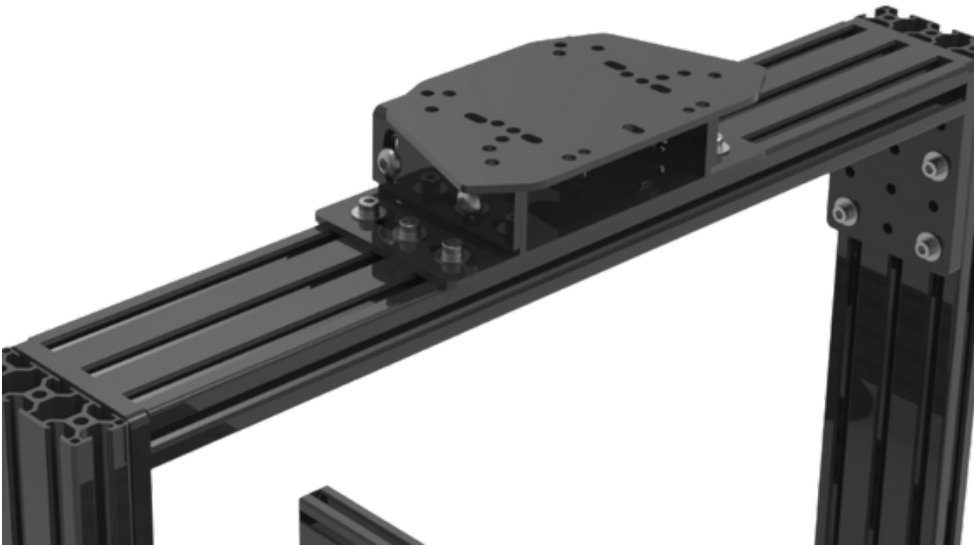
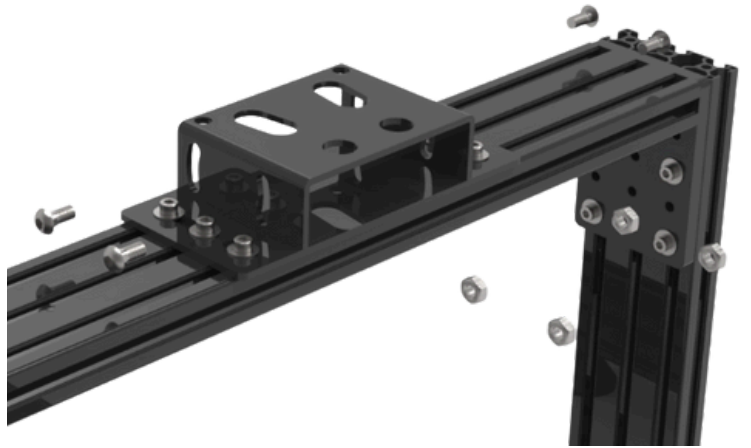
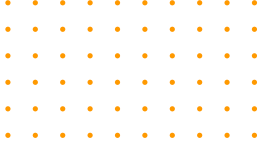

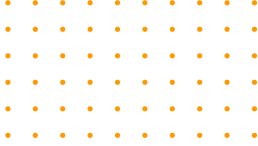

STEP-4

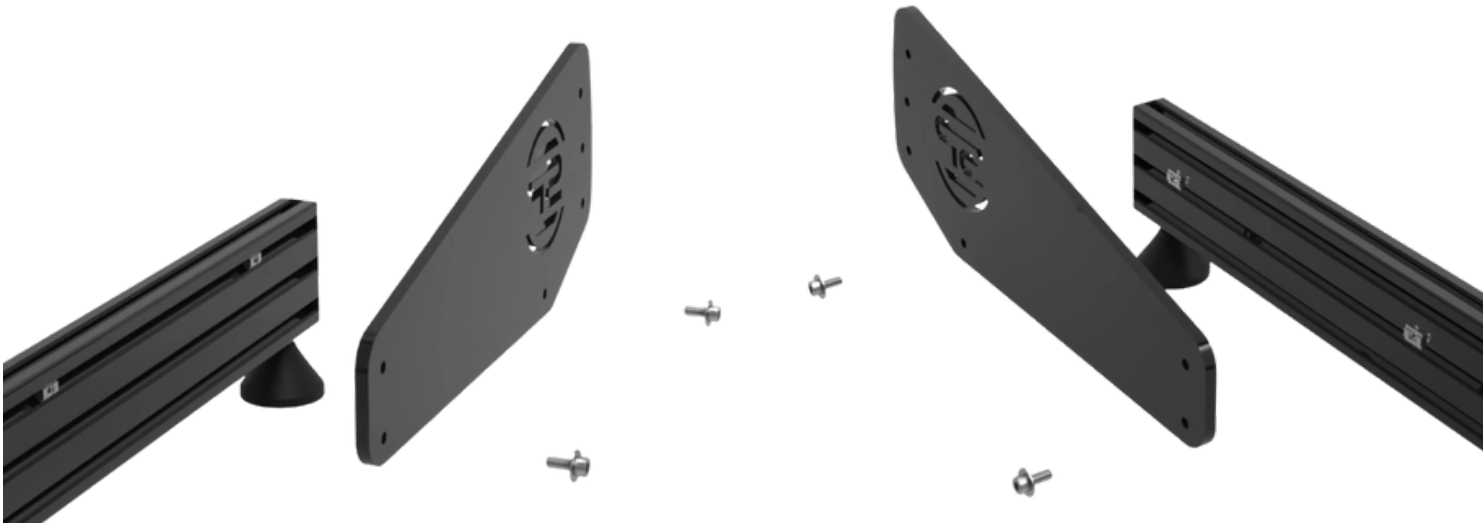
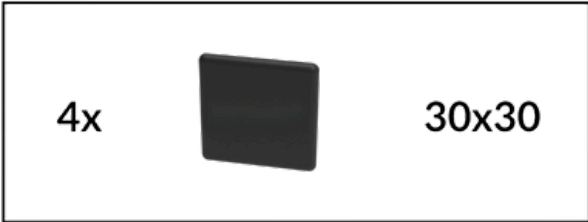
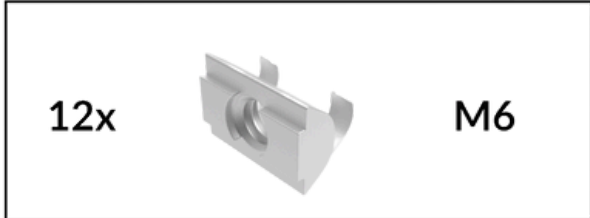
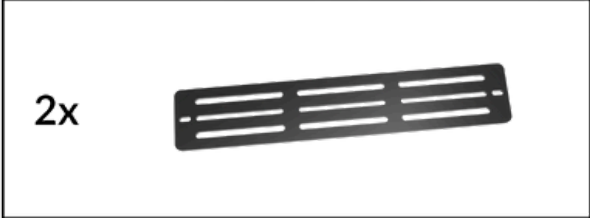
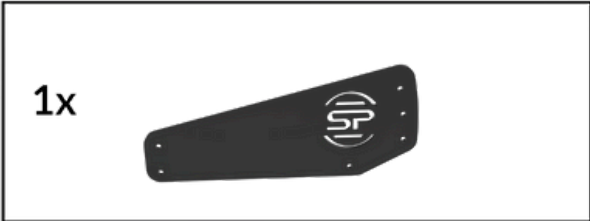

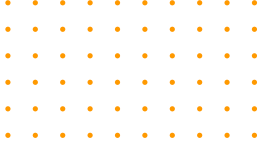

30x30x380

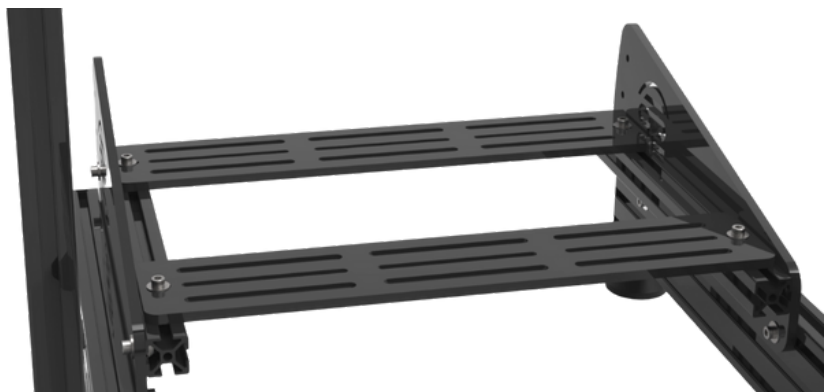

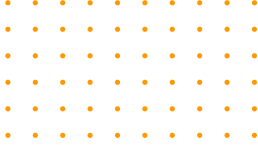

STEP-5

